

# ROCKWELL®

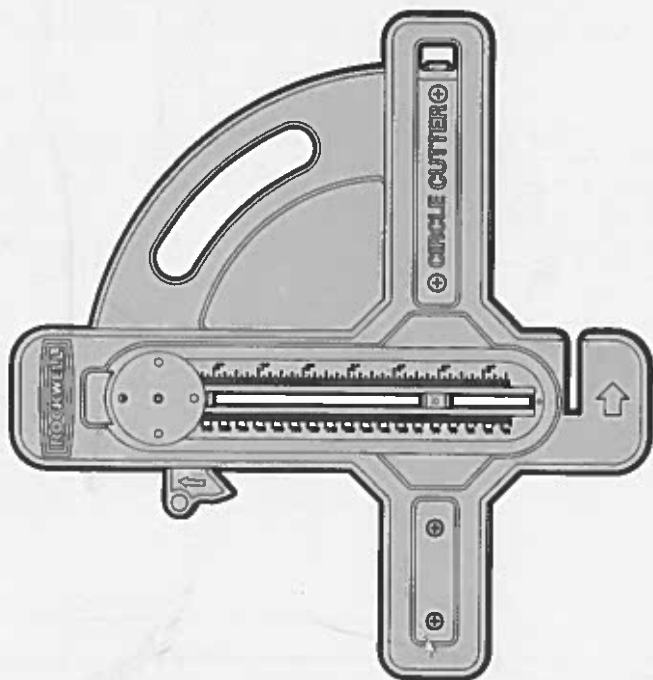

## **BladeRunner™** Accessories

**CIRCLE CUTTER**

**PAGE 7 ENG**

**CORTADORA CIRCULAR**

**PAGE 9 ESP**

**APPAREIL DE COUPE**

**PAGE 11 FRE**

**2Years**  
LIMITED WARRANTY

**RW9261**

Thank you for purchasing a ROCKWELL® power tool. We are confident that you will appreciate the quality of the product and you will be entirely satisfied with your purchase. Please read carefully the user safety and operating instructions on how to operate this product correctly within safety norms and regulations.

Gracias por su compra de un producto ROCKWELL®. Estamos seguros de que apreciará la calidad del producto y de que estará completamente satisfecho con su compra. Lea cuidadosamente las instrucciones de seguridad y de operación para obtener mayor información acerca de cómo utilizar éste producto correctamente dentro de las normas y reglas de seguridad.

Merci d'avoir choisi un produit de marque ROCKWELL®. Nous sommes certains que vous apprécierez la qualité de ce produit et qu'il saura vous satisfaire. Pour être renseigné sur toutes les méthodes de travail correctes et sécuritaires répondant aux normes et règlements de sécurité, veuillez lire attentivement la notice de sécurité et de fonctionnement présentée.



Visit us on the web at [www.rockwelltools.com](http://www.rockwelltools.com)



# RW9261

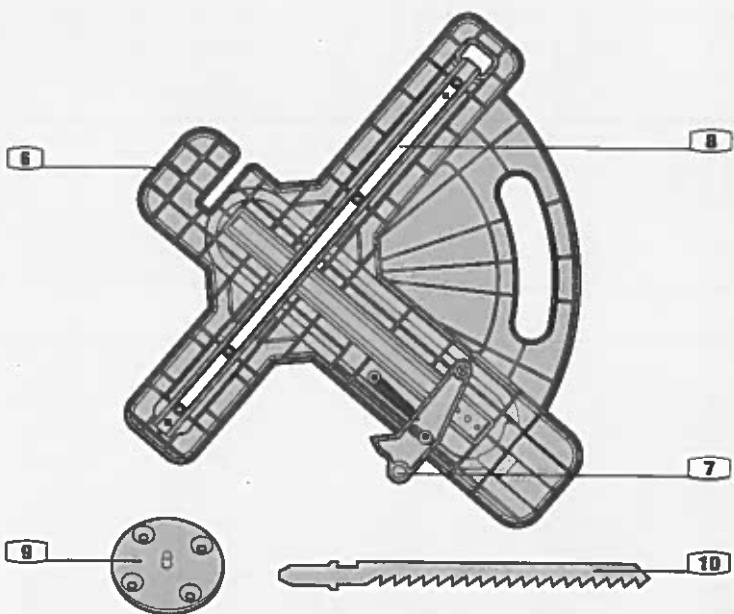
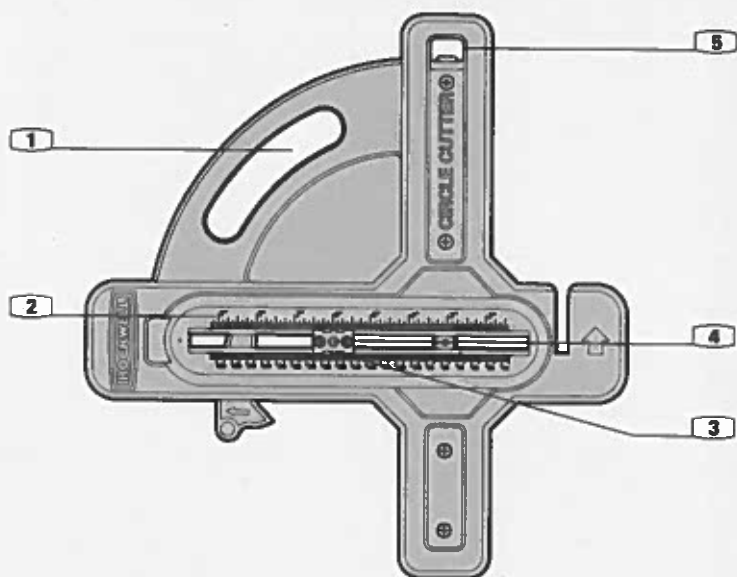

# RW9261

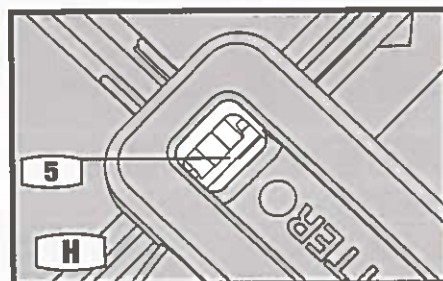
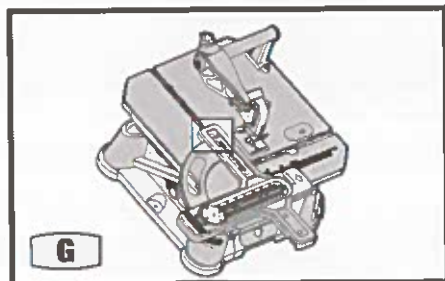
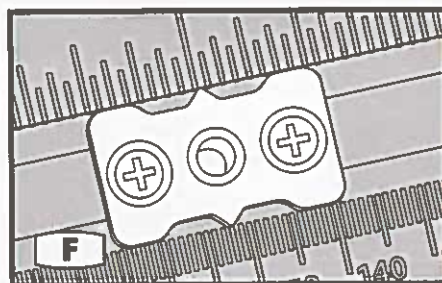
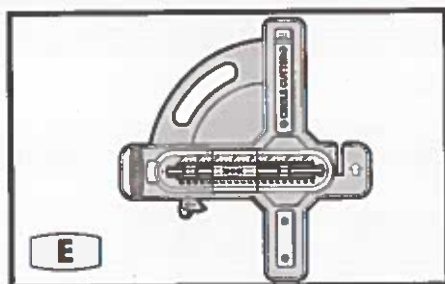
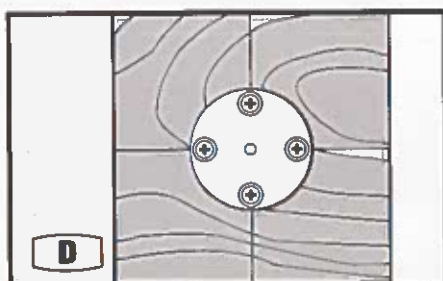
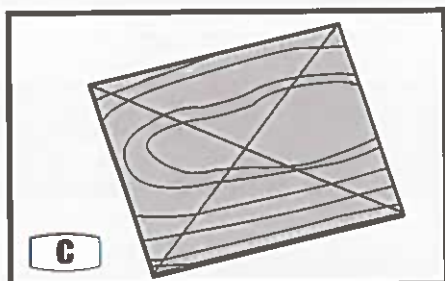
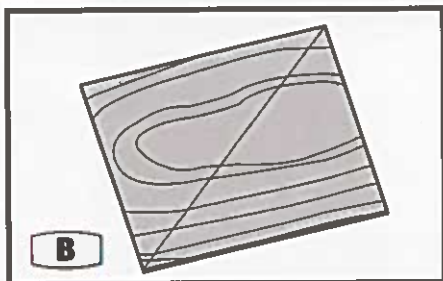
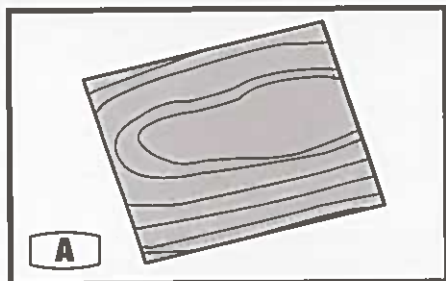

# RW9261

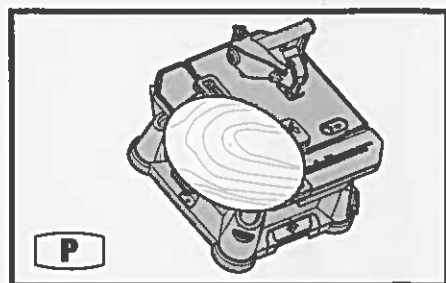
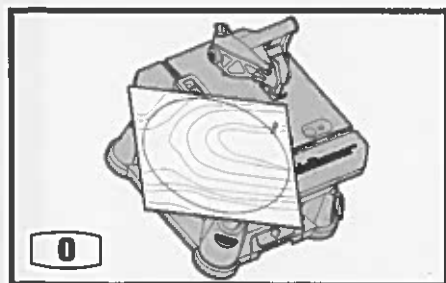
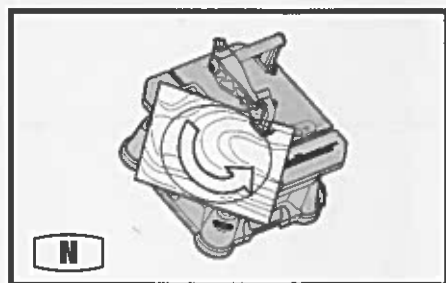
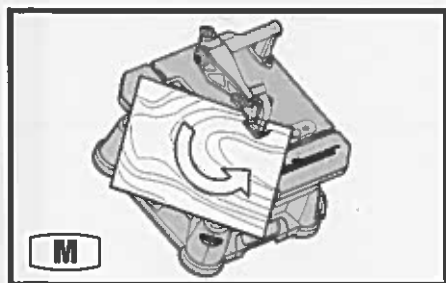
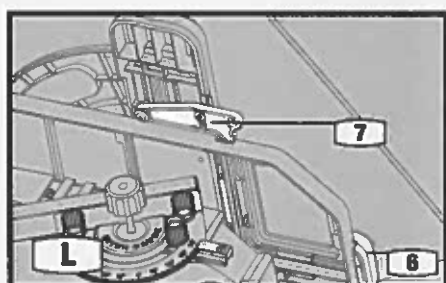
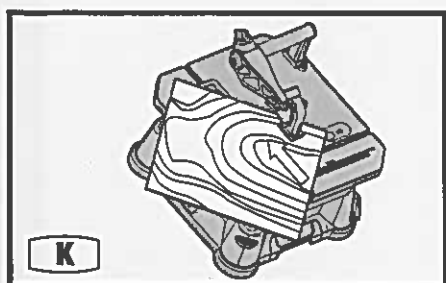
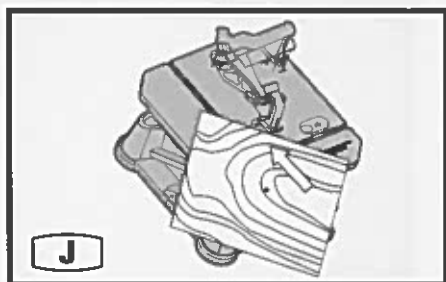
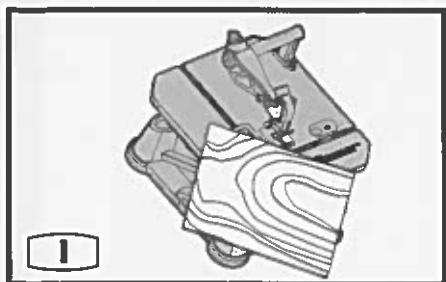

# RW9261

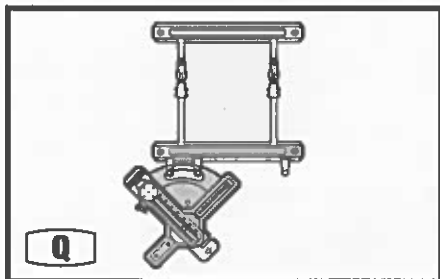

## COMPONENT LIST

- |    |                          |
|----|--------------------------|
| 1  | CARRY HANDLE             |
| 2  | SCALE FOR CUTTING RADIUS |
| 3  | INDICATOR                |
| 4  | PIVOT POINT              |
| 5  | ALIGNMENT WINDOW         |
| 6  | STOP                     |
| 7  | LATCH                    |
| 8  | GUIDE STRIP              |
| 9  | MOUNTING DISK            |
| 10 | SCROLL CUTTING BLADE     |

## ACCESSORIES

Mounting disk	1
Scrolling blade	1

We recommend that you purchase your accessories from the same store that sold you the tool. Use good quality accessories marked with a well-known brand name. Choose the type according to the work you intend to undertake. Refer to the accessory packaging for further details. Store personnel can assist you and offer advice.

## TECHNICAL DATA

Cutting diameter:	3" - 18"
Cutting depth in wood:	1"
Weight:	1.1lbs

## OPERATING INSTRUCTIONS

 **NOTE:** Before using the tool, read the instruction book carefully, as well as the instruction book from the BladeRunner™ itself.

This Circle Cutter is used to cut a circle in wood and designed for use with BladeRunner™ only.

 **WARNING:** Read and understand all safety instructions in your BladeRunner™ instruction manual before using this or any other accessory.

### UNPACKING

This product requires some assembly.

1. Carefully remove the tool and any accessories from the box. Make sure that all items listed in the component list are included.
2. Inspect the tool carefully to make sure no breakage or damage occurred during shipping.
3. Do not discard the packing material until you have carefully inspected and satisfactorily operated the tool.

### ASSEMBLY AND OPERATION

#### 1. PREPARING THE BOARD

- 1) Prepare a board slightly larger than the intended circle dimension. (Fig.A)
- 2) Mark the center of the board, drawing diagonal lines. (Fig.B&C)
- 3) Align the four holes in the mounting disk with the marked lines on the board. (Fig.D)

- 4) **Attach the mounting disk using the four screws supplied (Fig.D)**

## **2. SETTING UP THE CIRCLE CUTTER FOR USE ON THE BladeRunner™**

- 1) Make sure the scroll cutting blade is properly installed.
- 2) Adjust the center pivot indicator on the Circle Cutter to the appropriate radius. (Fig. E)  
Loosen the two screws with a Phillips screwdriver. Adjust the radius to the size required. Then, retighten the screws (Fig. F)
- 3) Partially engage the Circle Cutter into the front T-slot. Use the window (5) to help with the alignment. (Fig. G&H)

## **3. CUTTING CIRCLE**

- 1) Place the board onto the Circle Cutter, insert the mounting disc center into the pivot point. (Fig. I)
- 2) Start the machine and commence cutting in from the side. (Fig. J)  
Continue cutting in the direction of the arrow, until the Circle Cutter stops on the edge of the table. (Fig. K)  
Once the Circle Cutter has stopped on the table edge (6), the latch (7) on the underside will lock the Circle Cutter in position on table. (Fig. L)
- 3) Now rotate the work piece to continue cutting around in a circular direction. For best results, make sure to feed the workpiece very slowly.(Fig. M&N)
- 4) When the cut is complete, turn off the saw, remove the board and scrap piece from the Circle Cutter. (Fig. O&P) **Remove the mounting disk from the back of the work piece.**

## **4. STORING THE CIRCLE CUTTER**

The carry handle on the Circle Cutter is used to hang this assessor on the Wall Mount. (Fig.Q)

**NOTE: The mounting disk is easy to lose, please keep it safely stored.**

**Some projects may require that the alternate pivot be used or that the mounting disk be attached with glue or double-sided tape. Always use the blade supplied with the Circle Cutter, or a suitable replacement scroll blade. For accurate work, a slow feed rate is necessary, always allow the blade time to cut. In some extreme cases it may be necessary to reach the final size as a re-trim. In this situation we recommend an off cut about 1/16th to a 1/8th of an inch.**