

ROCKWELL®

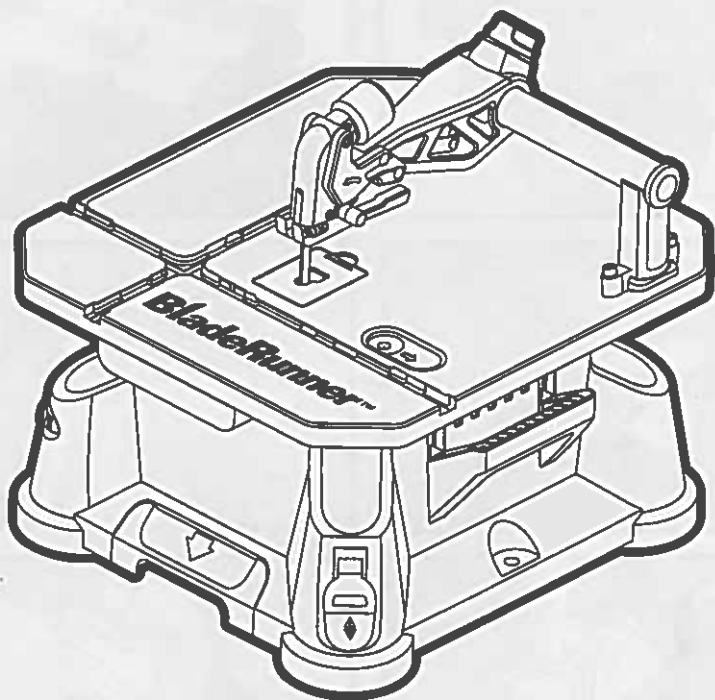

BladeRunner™

BLADERUNNER™

PAGE 10 ENG

BLADERUNNER™

PAGE 18 ESP

BLADERUNNER™

PAGE 27 FRE

2 Years
LIMITED WARRANTY

RK7320

RK7320

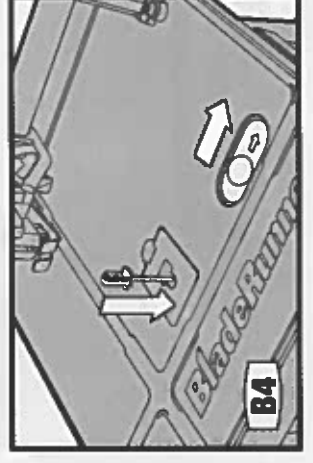
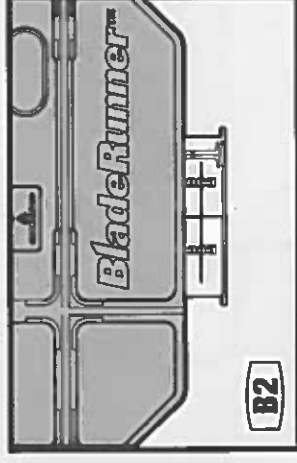
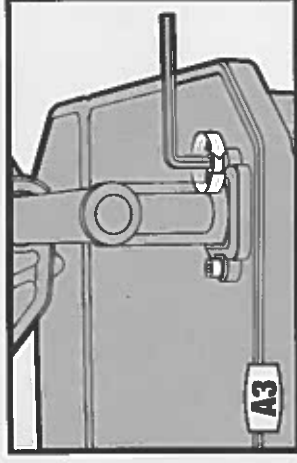
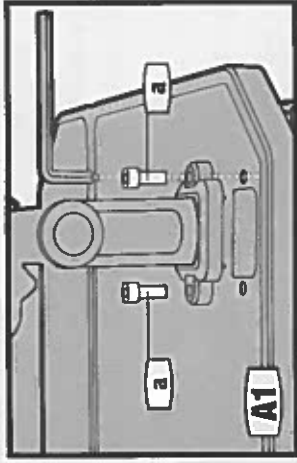
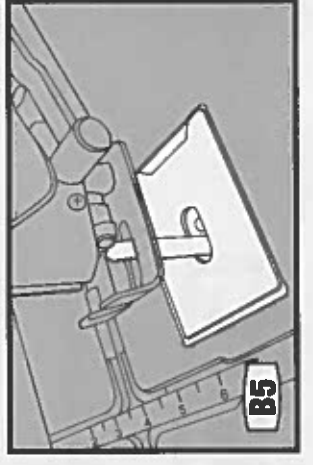
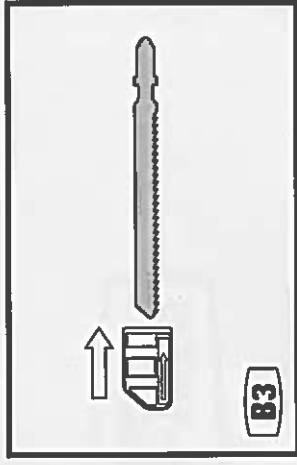
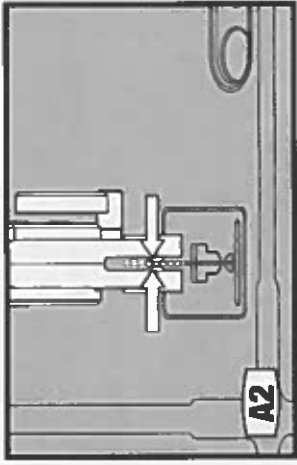

RK7320

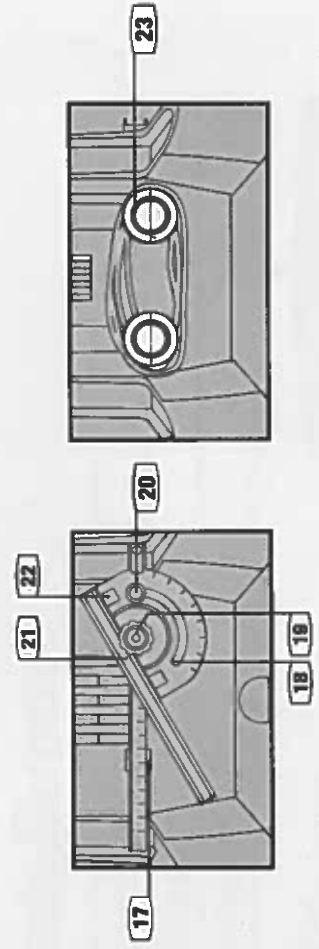
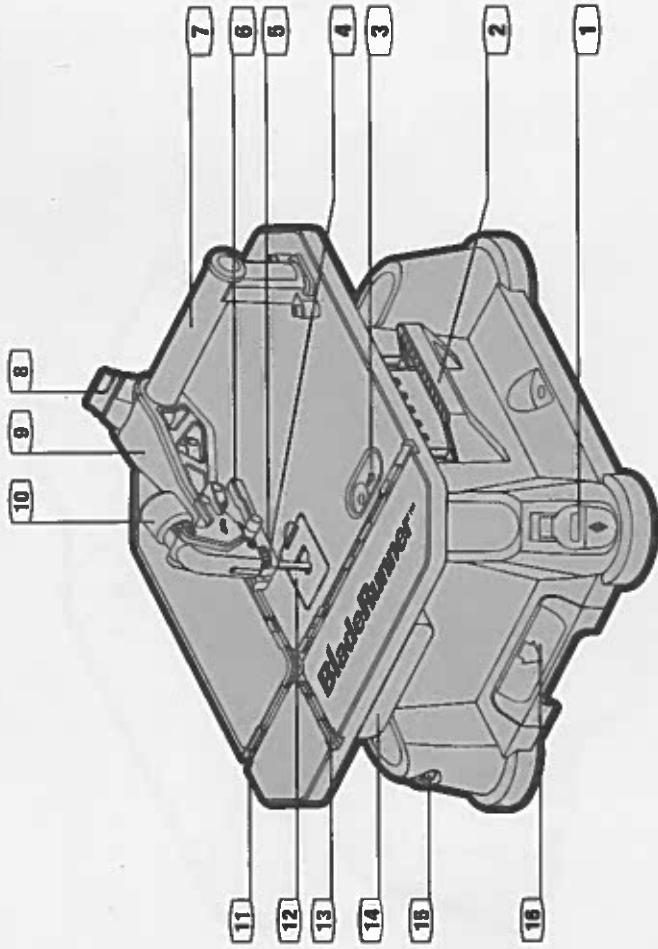

RK7320

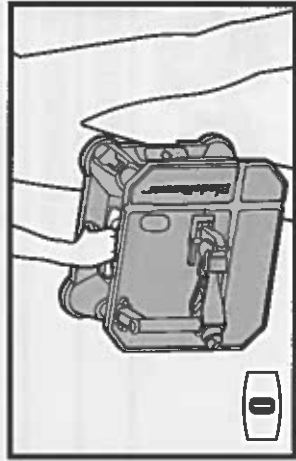
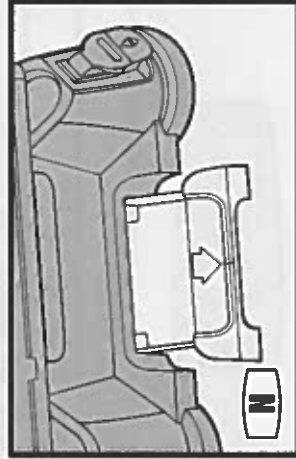
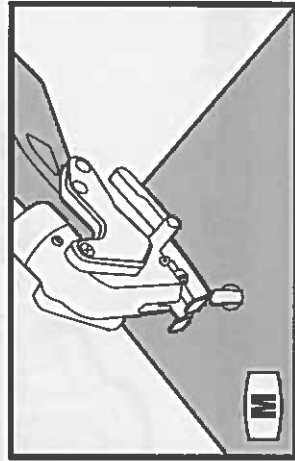
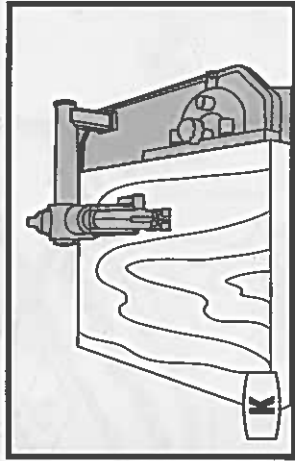
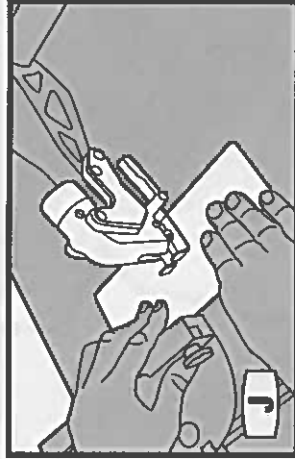
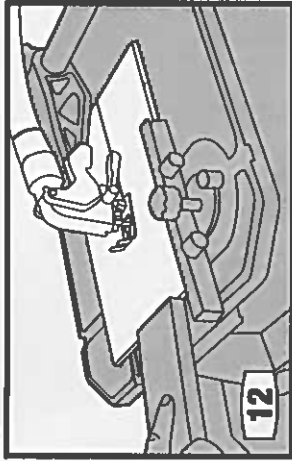
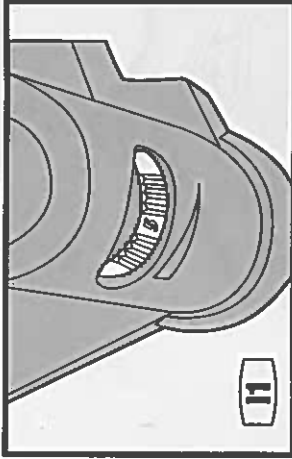

RK7320

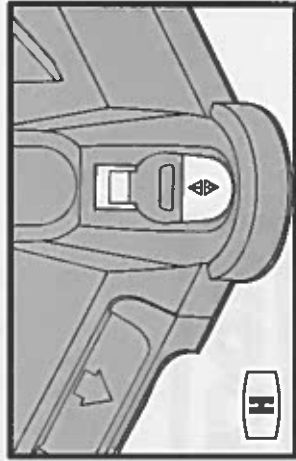
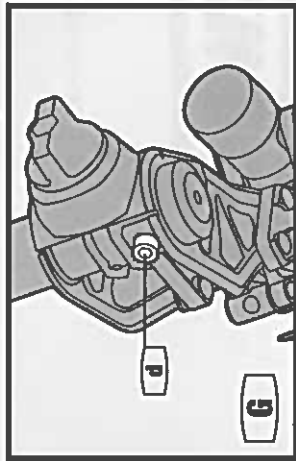
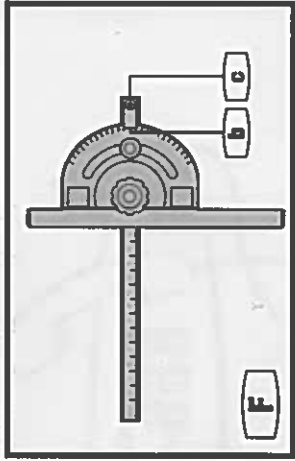
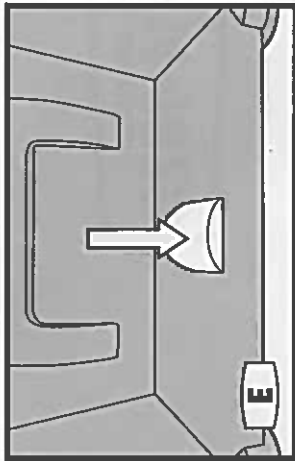
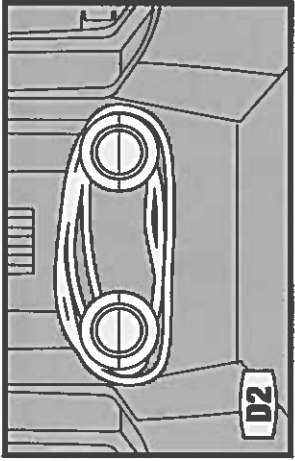
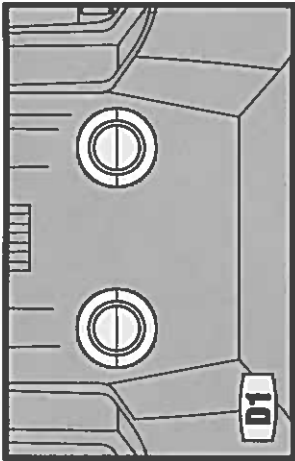
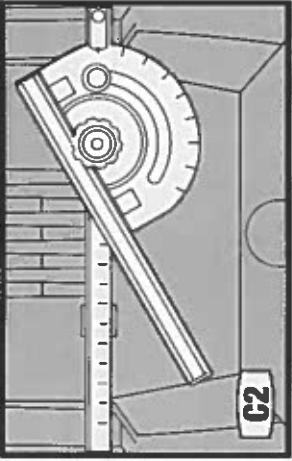
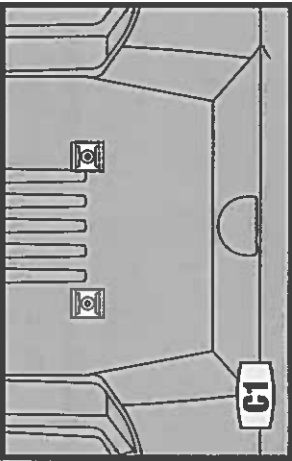

RK7320

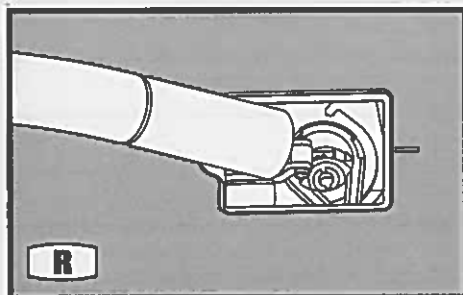
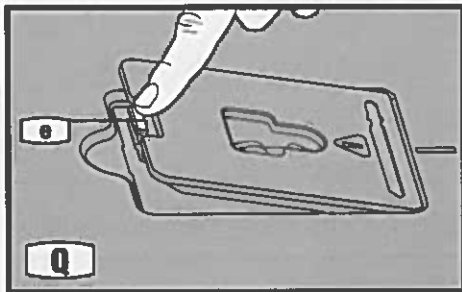
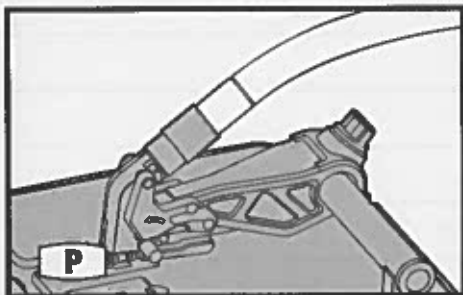

COMPONENT LIST

- 1** PADDLE SWITCH WITH SAFETY KEY
- 2** CARRY HANDLE
- 3** BLADE RELEASE FINGER PULL
- 4** BLADE GUIDE ROLLER
- 5** PRESSURE FOOT
- 6** QUICK RELEASE LEVER FOR PRESSURE FOOT
- 7** SUPPORT ARM
- 8** GUARD ARM CLAMP KNOB
- 9** GUARD ARM
- 10** VACUUM PORT
- 11** FENCE SLOT
- 12** TABLE INSERT
- 13** MITER SLOT
- 14** BLADE STORAGE DRAWER
- 15** VARIABLE SPEED CONTROL
- 16** DUST COLLECTION DRAWER
- 17** MITER GAUGE STORAGE
- 18** MITER GAUGE/RIP FENCE
- 19** RIP FENCE LOCKING KNOB
- 20** MITER GAUGE ANGLE LOCKING KNOB
- 21** MITER GAUGE/RIP FENCE SLIDING FACE
- 22** SLIDING FACE LOCKING KNOBS
- 23** CORD WRAP

ACCESSORIES

Miter gauge/rip fence assembly	1
Hex key	1
Blades:	
Wood cutting blade	1
Aluminum cutting blade	1
Steel cutting blade	1
Tile cutting blade	1
Scrolling blade	1
Blade grip	1
Vacuum adapter	1

We recommend that you purchase your accessories from the same store that sold you the tool. Use good quality accessories marked with a well-known brand name. Choose the type according to the work you intend to undertake. Refer to the accessory packaging for further details. Store personnel can assist you and offer advice.

SAFETY INSTRUCTIONS

WARNING: Some dust created by power sanding, sawing, grinding, drilling and other construction activities contains chemicals known to the state of California to cause cancer, birth defects or other reproductive harm. Some examples of these chemicals are:

- Lead from lead-based paints;
- Crystalline silica from bricks and cement and other masonry products and
- Arsenic and chromium from chemically-treated lumber.

Your risk from these exposures varies, depending on how often you do this type of work. To reduce your exposure to these chemical: work in a well ventilated area, and work with approved safety equipment, such as those dust masks that are specially designed to filter out microscopic particles.

READ ALL INSTRUCTIONS BEFORE USING THIS APPLIANCE

INSTRUCTIONS PERTAINING TO A RISK OF INJURY

GENERAL

A. GROUNDING INSTRUCTIONS

1. All grounded, cord-connected tools:

In the event of a malfunction or breakdown,

grounding provides a path of least resistance for electric current to reduce the risk of electric shock. This tool is equipped with an electric cord having an equipment-grounding conductor and a grounding plug. The plug must be plugged into a matching outlet that is properly installed and grounded in accordance with all local codes and ordinances.

Do not modify the plug provided – if it will not fit the outlet, have the proper outlet installed by a qualified electrician.

Improper connection of the equipment-grounding conductor can result in a risk of electric shock. The conductor with insulation having an outer surface that is green with or without yellow stripes is the equipment-grounding conductor. If repair or replacement of the electric cord or plug is necessary, do not connect the equipment-grounding conductor to a live terminal.

Check with a qualified electrician or service personnel if the grounding instructions are not completely understood, or if in doubt as to whether the tool is properly grounded.

Use only 3-wire extension cords that have 3-prong grounding plugs and 3-pole receptacles that accept the tool's plug.

Repair or replace damaged or worn cord immediately.

2. Grounded, cord-connected tools intended for use on a supply circuit having a nominal rating less than 150V:

This tool is intended for use on a circuit that has an outlet that looks like the one illustrated in Sketch A in Figure 1. The tool has a grounding plug that looks like the plug illustrated in Sketch A in Figure 1. A temporary adapter, which looks like the adapter illustrated in Sketches B and C, may be used to connect this plug to a 2-pole receptacle as shown in Sketch B if a properly grounded outlet is not available. The temporary adapter should be used only until a properly grounded outlet can be installed by a qualified electrician. The green-colored rigid ear, lug and the like, extending from the adapter must be connected to a permanent ground such as a properly grounded outlet box.

3. Grounded, cord-connected tools intended for use on a supply circuit having a nominal rating between 150-250V, inclusive:

This tool is intended for use on a circuit that has an

outlet that looks like the one illustrated in Sketch D in Figure 1. The tool has a grounding plug that looks like the plug illustrated in Sketch D in Figure 1. Make sure the tool is connected to an outlet having the same configuration as the plug. No adapter is available or should be used with this tool. If the tool must be reconnected for use on a different type of electric circuit, the reconnection should be made by qualified service personnel; and after reconnection, the tool should comply with all local codes and ordinances.

4. **Permanently connected tools:**

This tool should be connected to a grounded metal permanent wiring system; or to a system having an equipment-grounding conductor.

B. FOR ALL DOUBLE-INSULATED TOOLS

1. **Replacement parts**

When servicing use only identical replacement parts.

2. **Polarized Plugs**

To reduce the risk of electric shock, this equipment has a polarized plug (one blade is wider than the other). This plug will fit in a polarized outlet only one way. If the plug does not fit fully in the outlet, reverse the plug. If it still does not fit, contact a qualified electrician to install the proper outlet. Do not change the plug in any way.

C. FOR ALL TOOLS AS APPLICABLE

1. **KEEP GUARDS IN PLACE** and in working order.

2. **REMOVE ADJUSTING KEYS AND WRENCHES.**

Form habit of checking to see that keys and adjusting wrenches are removed from tool before turning it on.

3. **KEEP WORK AREA CLEAN.** Cluttered areas and benches invite accidents.

4. **DON'T USE IN DANGEROUS ENVIRONMENT.** Don't use power tools in damp or wet locations, or expose them to rain. Keep work area well lighted.

5. **KEEP CHILDREN AWAY.** All visitors should be kept at a safe distance from work area.

6. **MAKE WORKSHOP KID PROOF** with padlocks, master switches, or by removing starter keys.

7. **DON'T FORCE TOOL.** It will do the job better and safer at the rate for which it was designed.

8. **USE RIGHT TOOL.** Don't force tool or attachment to do a job for which it was not designed.

9. **USE PROPER EXTENSION CORD.** Make sure your extension cord is in good condition. When using an extension cord, be sure to use one heavy enough to carry the current your product will draw. An undersized cord will cause a drop in line voltage resulting in loss of power and overheating. Table 1 shows the correct size to use depending on cord length and nameplate ampere rating. If in doubt, use the next heavier gage. The smaller the gage number, the heavier the cord.

10. **WEAR PROPER APPAREL.** Do not wear loose clothing, gloves, neckties, rings, bracelets, or other jewelry which may get caught in moving parts. Nonslip footwear is recommended. Wear protective hair covering to contain long hair.

11. **ALWAYS USE SAFETY GLASSES.** Also use face or dust mask if cutting operation is dusty. Everyday eyeglasses only have impact resistant lenses, they are NOT safety glasses.

12. **SECURE WORK.** Use clamps or a vise to hold work when practical. It's safer than using your hand and it frees both hands to operate tool.

13. **DON'T OVERREACH.** Keep proper footing and balance at all times.

14. **MAINTAIN TOOLS WITH CARE.** Keep tools sharp and clean for best and safest performance. Follow instructions for lubricating and changing accessories.

15. **DISCONNECT TOOLS** before servicing; when changing accessories, such as blades, bits, cutters, and the like.

16. **REDUCE THE RISK OF UNINTENTIONAL STARTING.** Make sure switch is in off position before plugging in.

17. **USE RECOMMENDED ACCESSORIES.** Consult the owner's manual for recommended accessories. The use of improper accessories may cause risk of injury to persons.

18. **NEVER STAND ON TOOL.** Serious injury could occur if the tool is tipped or if the cutting tool is unintentionally contacted.

19. **CHECK DAMAGED PARTS.** Before further use of the tool, a guard or other part that is damaged should be carefully checked to determine that it will operate properly and perform its intended function

– check for alignment of moving parts, binding of moving parts, breakage of parts, mounting, and any other conditions that may affect its operation. A guard or other part that is damaged should be properly repaired or replaced.

20. DIRECTION OF FEED. Feed work into a blade or cutter against the direction of rotation of the blade or cutter only.

21. NEVER LEAVE TOOL RUNNING UNATTENDED.

TURN POWER OFF. Don't leave tool until it comes to a complete stop.

Figure 1

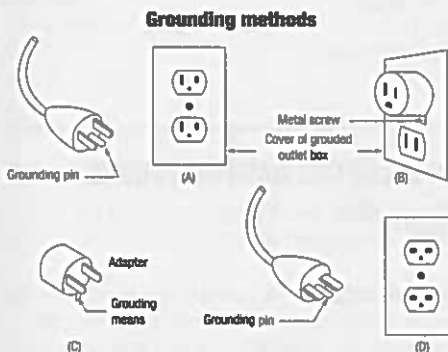

Table 1

		Minimum gage for corda					
Ampere	Rating	Volts		Total length of cord in feet			
		120V	240V	25ft.	50ft.	100ft.	150ft.
More Than	Not More Than	AWG					
0	6	18	16	16	14		
6	10	18	16	14	12		
10	12	16	16	14	12		
12	16	14	12	Not Recommended			

ADDITIONAL SAFETY INSTRUCTIONS FOR YOUR BLADERUNNER™

1. FOR YOUR OWN SAFETY READ INSTRUCTION MANUAL BEFORE OPERATING SAW

- Wear eye protection.
- Keep hands out of path of saw blade.
- Do not operate saw without guards in place.

- Do not perform any operation freehand.
- Never reach around saw blade.
- Turn off tool and wait for saw blade to stop before moving work piece or changing settings.
- Disconnect power (or unplug tool as applicable) before changing blade or servicing.
- Wear protective gloves when handling sharp blades.

SAVE THESE INSTRUCTIONS

A GLOSSARY OF TERMS

1. CROSSCUT

A cutting or shaping operation made across the width of the work piece cutting the work piece to length. Typically the cut is across the wood grain.

2. RIPPING OR RIP CUT

A cutting operation along the length of the work piece cutting the work piece to width. Typically the cut is along the wood grain.

3. MITER CUT

A cutting operation made with the work piece at any angle to the blade other than 90°.

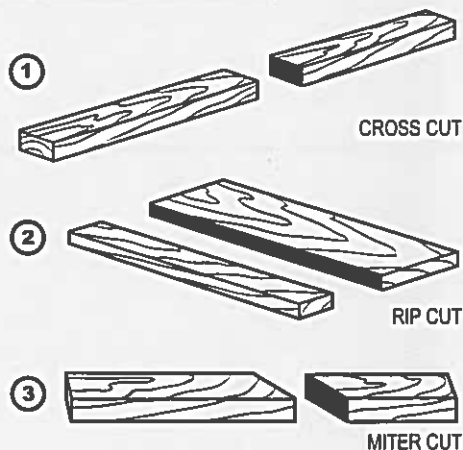

SYMBOLS



To reduce the risk of injury, user must read instruction manual



Warning



Double insulation



Wear dust mask



Wear eye protection



Wear ear protection

TECHNICAL DATA

Voltage	120 V~60 Hz
Amperage	5.5 A
No load speed	800-2800/min
Cutting capacity	
Wood	1-1/2"
PVC pipe	1-1/4"
Aluminum	3/8"
Steel	1/8"
Ceramic	3/8"
Stroke length	7/8"
Blade type	T shank
Blade length	4" or less
Table size	15-3/4"x17"
Protection class	□ / II
Weight	17.6 lbs

OPERATING INSTRUCTIONS



NOTE: Before using the tool, read the instruction book carefully.

BLADERUNNER™ — A compact, easy-to-use table-top tool for cutting wood, metal, plastic, and ceramic tile. Lightweight and portable for use right at the work area. Blade is stationary while user moves the material for easier, more precise work.

BEFORE PUTTING THE MACHINE INTO OPERATION

- All covers and safety devices have to be properly fitted before the machine is switched on.
- It must be possible for the blade to run freely.
- When working with wood that has been processed before, watch out for foreign bodies such as nails or screws etc.
- Before you actuate the paddle switch, make sure that the saw blade is correctly fitted and that the machine's moving parts run smoothly.
- If the cutting operation will produce a high amount of dust, especially hazardous dust such as ceramic tile or treated wood, connect an effective vacuum to the dust port.

ASSEMBLY



WARNING: To avoid injury from unexpected starting or electrical shock during assembly or adjustment, do not plug the power cord into a source of power.

WARNING: Make sure the saw is securely mounted to a workbench or other surface so that it cannot tip, slide or walk during operation.

1. MOUNTING THE SUPPORT ARM (SEE Fig. A1,A2,A3)

1. Place the support arm on work table. Using the two screws provided (a) loosely attach the support arm to the table. The screws are located in the small plastic bag with the vacuum adapter. Do not tighten the screws completely yet. (See Fig A1)
2. Insert the blade into the blade holder following the instructions outlined in the next section of this manual.
3. Lower the guard arm. Make sure the blade rests between the guide rollers. (See Fig A2)
4. Hold the support arm in place and tighten the screws. (See Fig A3)

2. CHANGE THE BLADE (SEE Fig. B1, B2, B3, B4, B5)

Make sure the saw is unplugged. Slacken the guard arm clamp knob and raise the guard arm (see fig B1). Wear gloves to protect your fingers from the sharp blade. Remove the desired jigsaw blade from storage. Attach the blade grip over the tip of the blade (See fig B3). Make sure the grip slides down the blade as far as it will go. Hold the blade by the grip. Open the blade holder by depressing the blade release button, and pull the release lever firmly and completely to the right. Hold the blade release open and insert the blade into the blade holder using the blade grip. Push the blade as far into the hole as possible, making sure the teeth are oriented perfectly toward the front of the saw. Continue to hold the blade in place and allow the blade release lever to slide slowly back to the left. The blade should now be locked in the proper position. If not, pull the blade release fully to the right and try again. The blade will seat properly if the blade release is pulled fully open, the blade pushed firmly to the bottom of the hole and held there, and the blade lever released smoothly. Remove the blade grip from the blade by pulling it upward.

NOTE: The BladeRunner™ is designed to use jigsaw blades 4" overall length or less. Do not use jigsaw blades longer than 4". Use blades with a t-shank only.

3. STORING THE BLADERUNNER ACCESSORIES

1. MITER GAUGE / RIP FENCE (SEE Fig. C1,C2)

Adjust the miter gauge/rip fence to the position as

shown in Fig C2 and tighten the lock knob. Then press the miter gauge/rip fence into the miter gauge storage on left side of the BladeRunner™.

2. POWER CORD (SEE Fig. D1,D2)

For easy storage, the power cord can be wrapped on the cord wrap on back side of the BladeRunner™.

3. MOUNTING HOLES (SEE Fig. E)

Securing the BladeRunner™ to a workbench or other stable surface during use is recommended. Use the mounting holes provided and your own screws or clamps, or purchase the Wall Mount, available separately.

ADJUSTMENT

WARNING: REMOVE THE PLUG FROM THE SOCKET BEFORE CARRYING OUT ANY ADJUSTMENT, SERVICING OR MAINTENANCE.

1. MITER GAUGE POINTER ADJUSTMENT (SEE Fig.F)

To check your miter gauge accuracy, use a combination square (not provided) to make sure the miter gauge body is 90 degrees to the shaft.

1. Loosen the miter gauge angle scale lock knob (20).
2. Rotate miter gauge body until it is 90 degrees to the square.
3. Tighten the lock knob (20).
4. If pointer (b) is not pointing to 90 degrees, adjust the screw (c), rotate pointer to 0 degrees. Tighten the locking screw (c).

2. ARM ALIGNMENT (SEE Fig.G)

The arm alignment with the blade is adjusted by factory, and you also can by instruction below:

1. Loosen guard arm clamping knob.
2. Loosen adjustment screw (d) under the arm pivot.
3. Move the arm inward or outward along the support tube until the blade locates exactly between the guide bearings without any bending of the blade.
4. Tighten the locking knob, tighten the adjustment screw.

OPERATION

WARNING: Always wear safety goggles or safety glasses with side shields when operating tools. Failure to do so could result in objects being thrown into your eyes causing possible serious injury.

WARNING: Do not use any attachments or accessories not recommended by the manufacturer. The use of attachments or accessories not recommended can result in serious personal injury.

WARNING: To reduce the risk of injury, the operator should use the accessory or attachment according to the instruction.

When the machine is not in use and to prevent unauthorized use, the switch should be locked in the "OFF" position. To do this, pull the locking key out of the ON/OFF switch and store the key in a secure place. With the key removed, the switch will not operate.

The tool should be operated at the speed in accordance with pertinent factors such as:

- The dimensions and material of the work piece; and
- The size and type of the saw blade.

WARNING: Operating the saw according to the instruction, never cut without the guard in place.

WARNING: Lifting or pressing the guard as indicated in figure C2, do not put your fingers between the tube and arm.

1. ON/OFF SAFETY SWITCH (SEE Fig. H)

To turn the machine on, lift the switch to the "ON" position. To turn it off, press the switch down to the "OFF" position.

TO "LOCK" THE MACHINE:

When the machine is not in use and to prevent unauthorized use, the switch should be locked in the "OFF" position. To do this, pull the locking key out of the ON/OFF switch and store the key in a secure place. With the key removed, the switch will not operate.

2. VARIABLE SPEED CONTROL (SEE Fig. I)

The variable speed control is under the work table. Adjust the variable speed control to increase or decrease the speed according to the material, material thickness and blade specification to be used (also possible during no load operation). See Chart 1 for general guidance on speed selection.

Avoid prolonged use at very low speed as this may damage your BladeRunner™'s motor.

Chart 1	
Material	Speed setting
Wood	5-6
Steel	3-4
Aluminum	4-6
PVC	3-4
Ceramic	3-5

TIPS: When you cut ceramic, please use low feed rate

at the end of cut. This will help decrease cracking at the end. We suggest you use a wooden push stick to complete the cut in ceramic (See Fig.12) Push in the middle of ceramic piece to support it.

Remember to use a vacuum to collect dust anytime tile is being cut.

GENERAL CUTTING RULES.

- ALWAYS allow the blade to reach operating speed before commencing a cut.
- ALWAYS wait until the blade has completely stopped before removing a workpiece or off-cut from close to the blade.
- ALWAYS use a sharp blade and use a feed rate which allows the blade to cut freely without excessive force.
- NEVER force a blunt blade to cut with excessive pressure.
- NEVER hold or push the work with hands in line with the blade.
- NEVER operate the BladeRunner™ without the guard arm assembly fitted and correctly lowered to guard and guide the blade.

3. CROSS CUT (SEE Fig. J)

— MAKING A CROSS CUT:

- Set the miter gauge to 0° and tighten locking knob. Insert miter gauge shaft to miter slot.
- Lower the guard arm to make the pressure foot contact the work piece. Then lower the quick release lever. Make sure the pressure foot is firmly against the work piece.

4. RIP CUT (SEE Fig. K)

- MAKING A RIP CUT:

- Set and lock the miter gauge at 0° using the angle knob.
- Slide the miter gauge into the fence slot (across the table).

NOTE: The fence can be set to the left or right of the blade, a larger off-cut can be accommodated if the fence is set to the right.

- Lock the fence at the desired width using the pointer in front of the blade.

NOTE: The fence must always be locked at 0 for a rip cut, any other fence angle will cause the work to jam between the fence and blade.

- carry out the cut as described in general cutting rules.

5. MITER CUT (SEE Fig. L)**- MAKING A MITER CUT:**

1. Follow the same procedures as you would for cross cut. Set the miter gauge to desired angle and tighten the lock knob.

6. INTERNAL CUT (SEE Fig. M)

BladeRunner™ is ideal for making inside cuts for detail work. To make an inside cut:

1. Drill a pilot hole in your workpiece. Make sure the diameter of the hole is larger than the blade you will use.
2. Make sure the saw is unplugged. Slacken the guard arm clamp knob (see Fig.B1) and raise the guard arm (see Fig.B2).
3. Thread the saw blade through the pilot hole in your workpiece.
4. Lower the guard arm to make the pressure foot contact the workpiece. Then lower the quick release lever. Make sure the pressure foot is firmly against the workpiece.
5. Perform the cut as per General Cutting Rules.
6. At the completion of the cut, again unplug the saw, raise the arm to remove the work.
7. Always remember to return the arm to the lowered position when finished.

7. DUST COLLECTION (SEE Fig. N & P)

Dust and chips from cutting will be collected in the dust drawer at the bottom of the machine.

NOTE: To ensure optimal dust collection, empty the dust drawer when it becomes filled to approximately 2/3 of its capacity.

For better cut line visibility and cleaner working environment, connect a vacuum cleaner or dust extractor to the hose connection on the blade guard. A vacuum **MUST** be used for hazardous dusts such as tile cutting.

8. CARRY HANDLE (SEE Fig. O)

BladeRunner™ has a built-in carrying handle on the side for easy, convenient transporting from one job site to another. Before carrying the saw, shut off the power and pull out the plug.

NOTE:

1. When carrying the saw, accessories shall be stored properly or locked up to avoid being lost.
2. Before carrying the saw, please empty the dust drawer.

MAINTENANCE

WARNING: Remove the plug from the socket before carrying out any adjustment, servicing or maintenance.

To insure proper operation and extend tool life, prevent dust from accumulating under the table insert.

1. Be sure to use a vacuum or dust extractor for dusty cutting operations such as ceramic tile. (See Fig. P)
2. If dust accumulate, remove the table insert by lifting the latch(e). (See Fig. Q)
3. Vacuum out the dust in a around the blade holder. (See Fig. R)
4. Reattach the table insert securely.

There are no user serviceable parts in your power tool. Never use water or chemical cleaners to clean your power tool. Wipe clean with a dry cloth. Always store your power tool in a dry place. Keep the motor ventilation slots clean. Keep all working controls free of dust. If you see some sparks flashing in the ventilation slots, this is normal and will not damage your power tool.

If the supply cord is damaged, it must be replaced by the manufacturer, its service agent or similarly qualified persons in order to avoid a hazard.